

AIR BATHTUB INSTALLATION

PRE-INSTALLATION STEPS

Barclay Products will not be held liable for damage to plumbing, floors and walls nor the installer. Thus, we advise customers to confer with a licensed professional if you have no or limited experience in installation of plumbing and other bathroom products.

Please follow all local plumbing codes throughout the installation process.

Also, please make sure to unpackage and examine all goods received for signs of damage. Should you locate any, please call our Customer Service department at 1-800-446-9700.

INITIAL PREPARATION

Collect all necessary materials needed for installation; please ensure all components of the air tub are readily available should you need to perform upkeep in the future.

TOOLS AND MATERIALS NEEDED:

- Basic Handtools
- Drill
- Tape Measure

ELECTRICAL ESSENTIALS

1. Disconnect electricity at the fuse box prior to starting electrical installation.
2. Use permanent wiring; don't utilize an extension cord. Only an approved/licensed electrician should conduct an electrical installation.
3. Find a spot to mount the blower motor; this should be within 15 feet of the tub, quickly accessible and in an uninsulated area. You need to have enough air space surrounding the motor to ensure it functions correctly. When mounting the blower behind a wall or underneath the floor, an approximately 30" x 15" access panel is required to enable servicing.
4. Connect to the junction box with the pre-installed type SJ wire. Separately, run a 120V, 60Hz, 15A GFI (Class A protected) electric circuit between the junction to the main fuse box. Consult local electrical codes if the space between your tub and the main fuse box exceeds 100 feet.
5. The below wiring diagram should be used as an aid to ready the electrical pieces for installation:

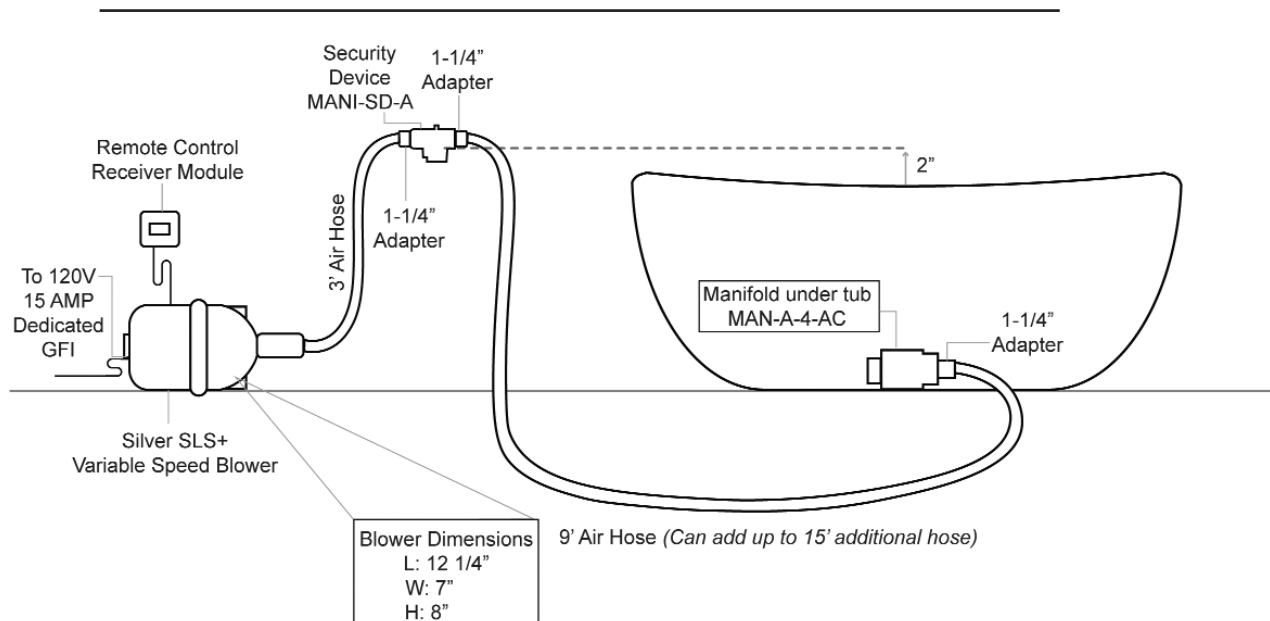

AIR BATHTUB INSTALLATION

AIR SYSTEM INSTALLATION

1. The blower motor should be secured in the location of your choosing. All electrical requirements should be complete at this time. Further, the receptacle should be readied.

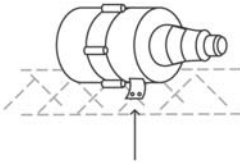

2. The remote control receiver module should be plugged into the required location on the blower motor's side. This remote control receiver module should be hung to a nearby wall or other surface; in plain view and as close to the tub as feasible.

IMPORTANT: The remote control will not work correctly if the receiver module isn't in plain view of the tub.

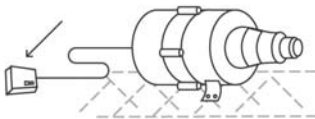

3. One end of the 3-foot air hose should be joined to the blower motor outlet. An included hose clamp will secure the hose to the outlet. The other side of the hose should be connected to the security device (an additional hose clamp is included to assist with this).

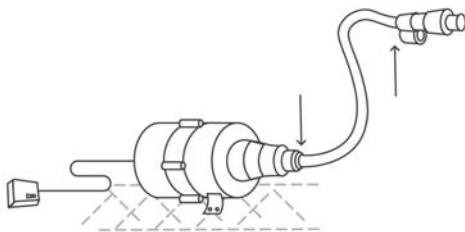

4. Join one end of the 9-foot air hose to the other end of security device (with another hose clamp). The opposite end of the hose should be connected to the manifold below the tub with another hose clamp used to secure it.

NOTE: Included 1 ¼" hose adapters are needed at both sides of the hose to facilitate the connections. If the air hose is too short it can be expanded as much as 15 feet.

5. Use included hardware to attach the air tub's security device to a wall or nearby surface.

IMPORTANT: You must install the security device 2" higher than the lowest point of the tub's rim. Prior to mounting, check the tub specifications or this measurement before securing the security device.

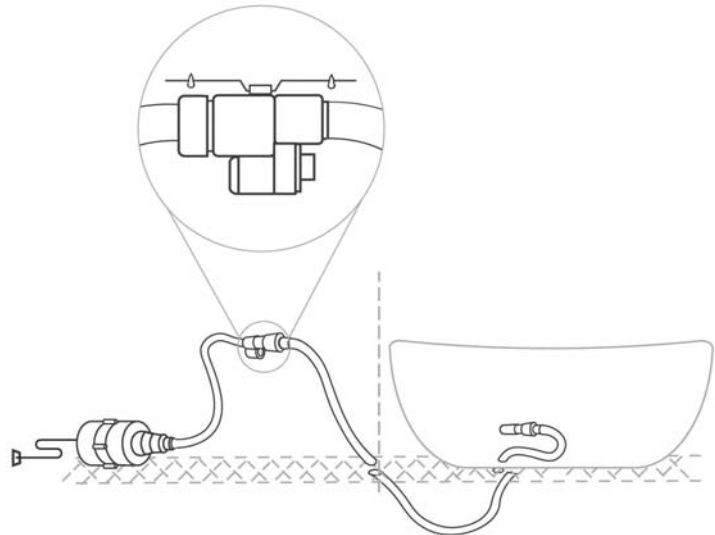

6. The blower motor should be plugged into the dedicated electrical receptacle.

AIR BATHTUB INSTALLATION

PROGRAMMING REMOTE CONTROL

1. Push the second and third buttons on the remote at the same time and hold for 4 seconds. This should synchronize the remote and make it ready for usage.

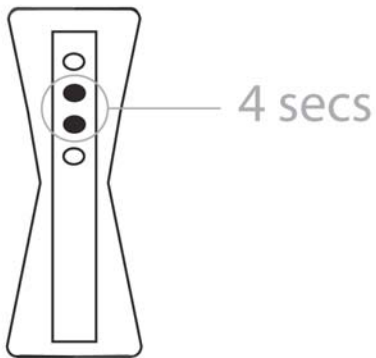

2. Should the above step fail, perform a reset by unplugging the system for 1 minute then plugging it in again. You have 15 seconds from this point to move forward with an additional attempt to program the remote.

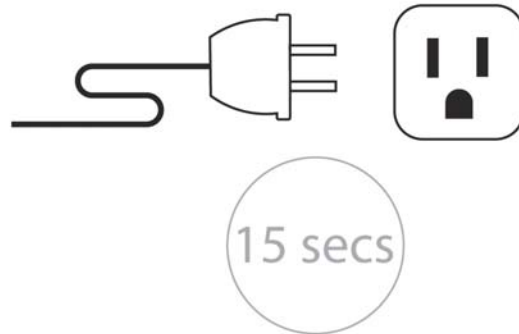

Remote Control CG+/RTC-SENSOR-WP



12-15 year battery life

Replacement Module available: CG-RT-MOD-05-NC

INSIDE VIEW OF TUB

Oval bathtub

Sample jet configuration

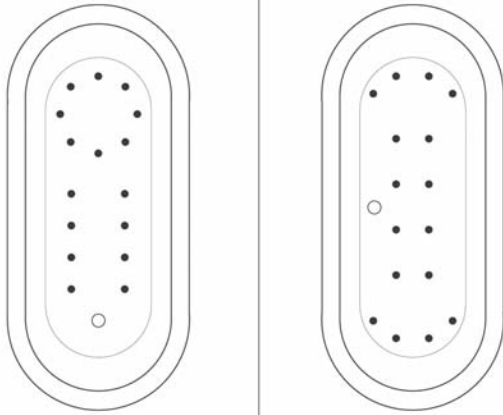

with end drain

with center drain

Rectangular bathtub

Sample jet configuration

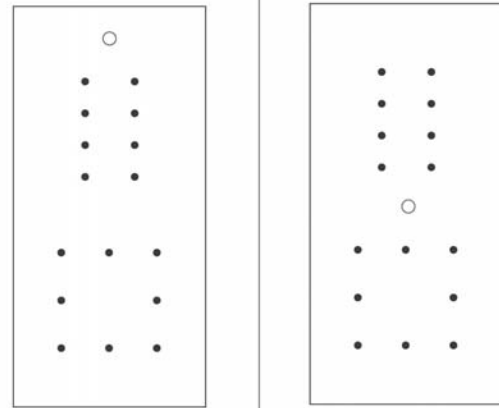

with end drain

with center drain

Round bathtub

Sample jet configuration

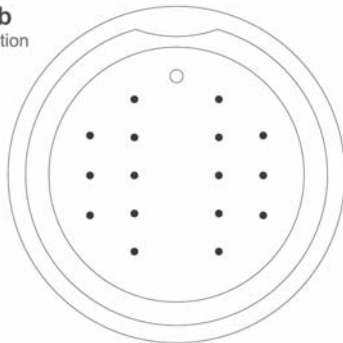

These diagrams are general representations.
Jet placement may vary dependent on tub shape

Features:

(16) Maxi Air Jets



Elbows for air jets



Tees for air jets

AIR BATHTUB INSTALLATION - FAQ

1. Can the air blower be installed anywhere other than under the bathtub?

Yes, it can. The air blower can be installed up to 15 feet away from the bathtub. However,

- Never insulate the blower. But, it is recommended to insulate the air hose to prevent cooling of the air circulating within.
- The ambient air surrounding the air blower must be maintained at the same temperature as the room where the bathtub is installed. The blower was not designed to heat cold air from a basement or a garage.

2. The blower starts on its own.

Almost all air blowers are standard with a built in automatic purge cycle that will start 20 minutes after the use of the system. However,

- If there is a power outage, the purge cycle could be activated.
- If the system is equipped with a water detector, the purge cycle will start every time there is water in the bathtub (after you shower, after cleaning the bathtub, etc.).
- If this happens often even if the system has not been used, contact your dealer. The keypad could be defective and will have to be replaced.

3. The purge cycle does not start.

First verify with your distributor to make sure that your blower is equipped with this option. If it is:

- Verify that the power to your system does not go through a timer or a security switch. If the timer or switch was shut off before the purge cycle count down has finished, the blower will not turn on.
- Verify that there is no water in the bottom of your bathtub. Your system may be equipped with a water detector that is preventing the purge cycle to start.

4. I can hear the blower functioning but there is no air coming out of the jets.

Verify that the 1 1/4" air hose is well connected between the blower and the manifold. If not, reinsert the hose and tighten the clamp with the screw (if the screw has fallen off, replace it with another fitting screw) to maintain it in place.

5. I can hear the blower functioning but not all jets are working.

Sometimes jets can be obstructed by either installation debris or simply calcium build-up. To take care of this problem simply:

- Fill the bathtub with enough hot water to cover the jets on the bottom of the bathtub.
- Let the system run for approximately one (1) minute.
- While the system is running locate the jets that are not functioning and gently tap on the head of the jet with a rubber instrument (screwdriver handle or mallet).

6. My blower turns on but will only function for 10 to 15 minutes and then it shuts off.

The blower is equipped with a thermal protection. If, for any reason, the blower gets too hot it will automatically shut off. Let your blower cool down for approximately 1 to 1 1/2 hours. It should function normally after this time. To prevent from happening again,

- Verify that the blower has not been insulated.
- Verify that there is sufficient air circulation surrounding the blower.

AIR BATHTUB INSTALLATION - FAQ

7. The air coming out of the jets is cold.

To verify that the air-heating element is functioning normally, turn on your system and let it run. After approximately 5 minutes, touch the air hose that is connected to your blower. It should feel hot.

- If the hose does not feel hot, contact your distributor who will guide you through the procedure to get your blower changed.
- If the air hose feels hot, the blower is not defective. The cool sensation is something that happens from time to time. This is mainly caused by the theory that air blown onto wet skin will seem cool. As an example, the air coming out of a hand dryer in a public rest room will seem cool to the hands as long as they are wet.

Unfortunately some people are more sensitive to this effect than others. The solution is to change positions in the bathtub and the sensation will diminish.

8. The air blower functions but the options on my keypad do not always function.

- If the problem is only with the « + » button; please note that your system starts at a maximum speed. Therefore, pressing this button will have no effect. To verify the proper function of your system press the « - » button; the speed should go down. Then press the « + » button and the speed will increase.
- If it is a problem with any other button, your keypad could be defective. Sometimes a humidity problem can occur within the electronic system if a wet cloth is left too long on the keypad or if the keypad label is cracked. Contact your distributor who will guide you through the procedure to have your keypad changed.

9. Nothing seems to work.

- Check the main power box of the house if the breaker is at the ON position.
- Check if the ground fault circuit interrupter (GFCI) has not tripped.

Most manufacturers test their product before it leaves the plant. Risks that nothing works are almost null. Interrupt the current for 15 seconds and then reconnect it. This should solve your problem.

10. I press on the air push button but the system does not turn on or off.

With an air push button the solutions are quite simple most of the time.

1. If the button is hard to press or comes back too slowly to its initial position, there may be too much air accumulated within the hose.
 - To correct the problem, locate the transparent hose and with a thin pin, poke one or two holes through it to let the air out. (This will not harm your system in any way).
 - Verify that the hose is not kinked or bent preventing the air from flowing easily.
2. If the button is easy to manipulate, unplug the transparent hose from under the button and gently blow into it.
 - If the blower starts, the problem is in the air push button.
 - If the blower does not start, the problem is in the blower.

In both cases, contact your distributor for the procedure to have the defective part replaced. Please inform them of your testing results.

11. My ground fault circuit breaker switches off.

- If your bathtub is equipped with both a whirlpool pump and an air blower, verify that each unit is connected to a separate ground fault circuit interrupter (GFCI).
- Sometimes it can occur that the interrupter (GFCI) is too sensitive. To verify this, disconnect the blower and connect either a hair blower or a light bulb. If the ground fault circuit interrupter trips again, it may be that there is a short circuit somewhere in the electrical line. Have your electrician verify the problem. If the problem persists, the ground fault circuit should be replaced.

INSTALLATION INSTRUCTIONS FOR **REMOTE CONTROL**

The remote control only operates CG Air Systèmes
Millenium MS+ & Silver SLS+ blower series and CG Air electronic controls **Evolution**

RECEIVER MODULE INSTALLATION

1 Receiver module installation

A. The receiver module must be installed under the bathtub rim.

IMPORTANT:

- In order to obtain the best reception possible, we recommend not to install the receiver module next to the faucets or metal piping.
- Location of the receiver module must be easily accessible from the outside of the bathtub for maintenance.

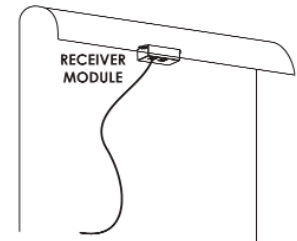

2.A Remote control and keypad used to activate the system

- A. Plug in the cables as shown on the drawing
- B. Once everything is connected, the remote control is ready for synchronization

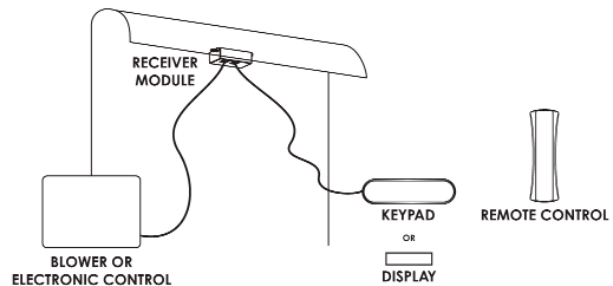

2.B Remote control only, to activate the system

- A. Plug in the cable as shown on the drawing
- B. Once everything is connected, the remote control is ready for synchronization

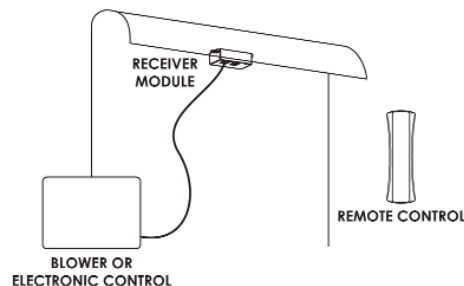

SYNCHRONIZATION

- A. Once the system has been connected, the remote control must be synchronized with its receiver module.
- B. Switch off the main breaker or unplug the system and switch it on again.
- C. From this moment, you have 15 seconds to proceed with the synchronization.
- D. Press simultaneously on the button 2 + 3 of the remote for 4 seconds.
- E. The remote control is now synchronized and ready to use.
- F. If the synchronization is not successful the first time, you should resynchronize, starting from step B.

The following components are necessary

One (1) remote control

Two (2) magnets

One (1) receiver module

One (1) cable

REMOTE CONTROL INSTALLATION

- 1** A. Determine appropriate location for the remote control in the bathtub.

Determine backside location of magnets

- Hold the remote control in the chosen location.
- From the exterior of the bathtub position the supplied magnets, the attraction force will guide you to the proper area and they will hold in place.
- Mark the position of the magnets with a marker or pencil.

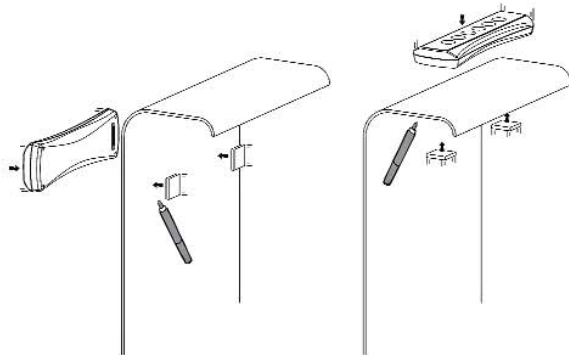

2

CAUTION: Magnets always have a positive and negative side and will only be attracted to one side. Consider this to avoid applying the silicone to the wrong side.

Install magnets on backside

- Apply a dab of silicone to the magnets, place and maintain in the premarked position.
- Let dry in this position.

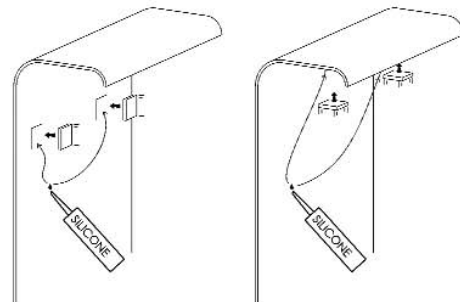

3

WARNING: The magnets are extremely powerful despite their small size. Use caution while installing and handling to avoid injuries caused by a sudden movement of the magnets clinging together and possibly pinching fingers, skin or other. Persons with physical conditions that could be affected by magnetic fields should avoid using it and/or consult with their physician.

